

LM3509 Evaluation Board

National Semiconductor
Application Note 1594
Travis Eichhorn
June 2007



Introduction

The LM3509 is an asynchronous boost converter with two separate outputs. The first output (MAIN) is a constant current source for driving up to 5 series white LED's. The second output (SUB) is configurable as a constant current source for driving up to 5 series white LED's, or as a feedback input to set a constant supply voltage for OLED panel power. The maximum LED current per output is set via a single external low power resistor. An I²C compatible interface allows for independent adjustment of the LED current in either output from 0 to max current in 32 exponential steps. When configured as

a white LED + OLED bias supply the LM3509 can independently and simultaneously drive a string of up to 5 white LED's and deliver a constant output voltage of up to 21V for OLED panels.

The evaluation board is set-up to drive 2 strings of 5 white LEDs (OSRAM, LW_M67C, $V_F = 3.6V$ at 20mA). These are set-up with 5 LED's in the MAIN string and 5 LED's in the SUB string. Alternatively, resistors can be installed in the R1 and R2 pads to make the device a voltage output boost converter for OLED display powering (see Output Voltage Setting (OLED Mode)).

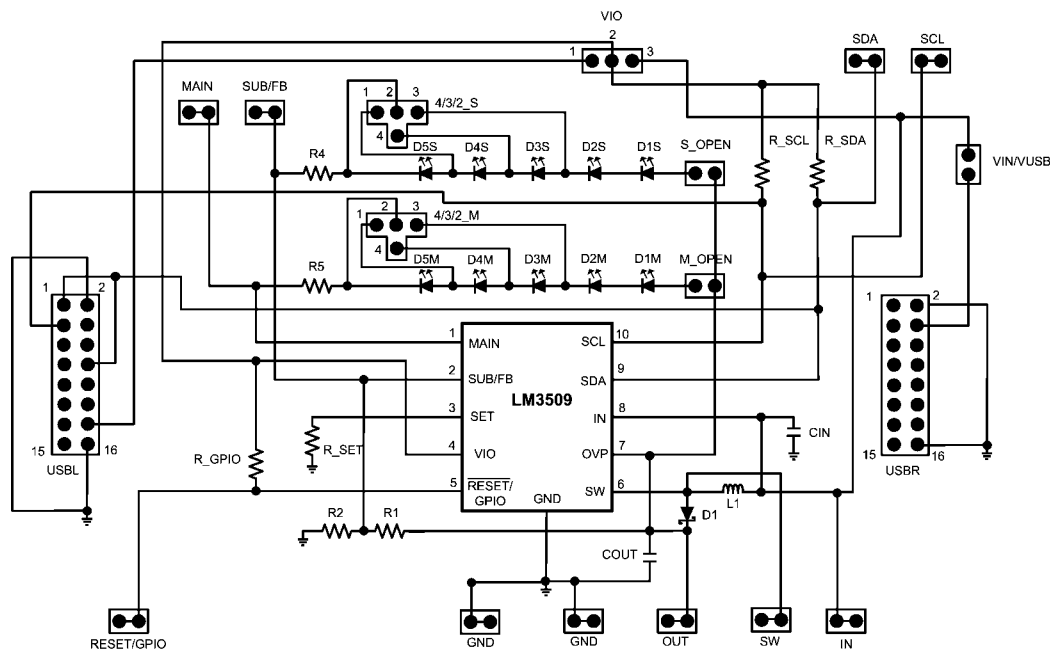

30011101

FIGURE 1. LM3509 Evaluation Board Schematic

Bill of Materials

| Designator | Component | Manufacturer |
|----------------------|--|------------------------|
| | LM3509SD, 10-Pin LLP (SDA10A) | National Semiconductor |
| L1 | 10 μ H, VLF3012AT-100MR49 | TDK |
| CIN | 1 μ F, 10V Ceramic C1608JB1A105M | TDK |
| COUT | 1 μ F, 25V Ceramic C1608JB1E105M | TDK |
| D1M–D5M, D1S–D5S | White LED, LW_M67C | Osram |
| R4, R5 | 0 Ω Resistor, CRCW0603 | Vishay |
| R_SET | 12.1k Ω , CRCW06031212F | Vishay |
| R_SDA, R_SCL, R_GPIO | 10k Ω , CRCW06031002F | Vishay |
| D1 | Schottky, 30V, 0.5A, B0530WS | Diodes Inc. |
| R1, R2 | Unpopulated (used for Constant Voltage Oupput) | |

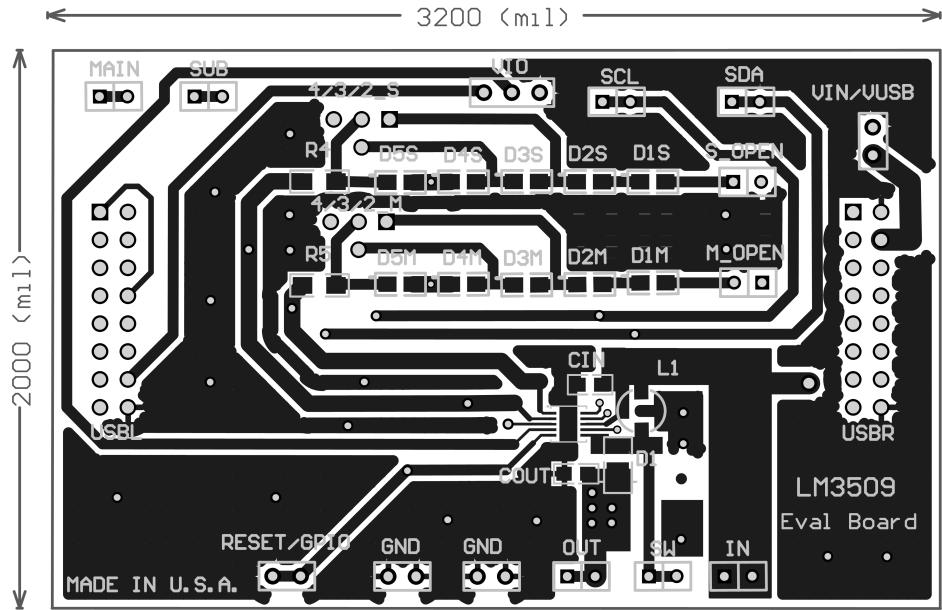

880013160-001 REV A

880013160-001 REV A

30011102

FIGURE 2. LM3509 Evaluation Board Layout (Top Side)

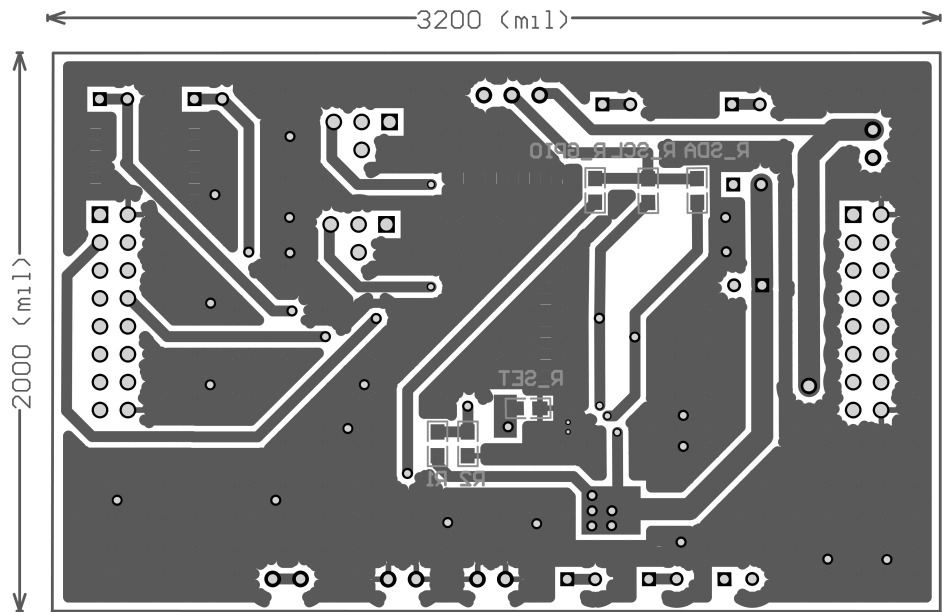

880013160-001 REV A

880013160-001 REV A

30011103

FIGURE 3. LM3509 Evaluation Board Layout (Bottom Side)

Board Operation

To operate the LM3509 Evaluation Board, connect a 2.7V to 5.5V supply between the IN header and GND and attach an I²C interface using one of the methods described in the EXTERNAL CONTROL INTERFACE section of this document.

External Control Interface

There are two methods for controlling the LM3509 Evaluation Board. The first option is via a National Semiconductor USB Interface Board. The second option is by using the SDA and SCL headers available on the upper right corner of the board. When option 1 is used the USBL and USBR connectors plug directly into the National Semiconductor USB Interface Board. The connectors are keyed so they will only fit one way. On the LM3509 Evaluation Board the VIN/VUSB jumper allows for power to come from IN or from the USB Interface board. The USB Interface Board has its own regulator that supplies 3.3V (see documentation for the National Semiconductor USB interface board). When power from the USB Interface board is desired connect a jumper across VIN/VUSB, if power is supplied from the IN header leave VIN/VUSB open. DO NOT jumper VIN/VUSB while an external source is connected to IN as this will make a conflict between the USB Interface Board and the external power supply. This can permanently damage the National Semiconductor USB Interface Board. The USB interface board interfaces directly with the LM3509.exe graphical interface via the PC (see LM3509 I²C Compatible Interface Program section).

If the National Semiconductor USB Interface Board is not used then control of the LM3509 Evaluation Board is done by connecting an external I²C compatible interface directly to the SCL and SDA headers. Both the SDA and SCL lines have 10k Ω pull-ups installed on the back side of the board.

Board Description

The following section describes the jumper settings on the LM3509 Evaluation Board.

M_OPEN and S_OPEN are 2 position jumpers placed between the LM3509's OUT terminal and the top side of the LED strings. Short M_OPEN to connect OUT to the MAIN LED string and remove the jumper to open the MAIN string. The same applies to the S_OPEN jumper and the SUB string. These are useful for testing OVP and/or inserting a current meter in series with the LEDs.

Both 4/3/2_M and 4/3/2_S are 4 position jumpers that allow for different combinations of series LEDs in either the MAIN or SUB LED strings. Both 4/3/2_S and 4/3/2_M have their center pin (pin 2 in figure 1) connected to the bottom of the LED string. Referring to 4/3/2_S, connecting pin 2 to pin 1 will short D5S making the SUB string a 4 LED configuration. Connect pin 2 to pin 4 to short D4S and D5S resulting in a 3 LED configuration. Connect pin 2 to pin 3 for a 2 LED configuration (D3S – D5S shorted). Leave 4/3/2_S open for a 5 LED configuration. The operation for 4/3/2_M is the same as 4/3/2_S only it applies to the MAIN LED string.

VIO is a 3-pin, 3-position jumper. The left pin (pin 1 in Figure 1) connects to the 3.3V supply from the USB board connector

(USBL). The right pin (pin 3) connects to IN of the LM3509. The middle pin (pin 2) connects to VIO of the LM3509 and the top side of the pull-up resistors (R_SDA, R_SCL, and R_GPIO). When operating the device with the National Semiconductor USB Interface Board the jumper can be connected from pin 1 to pin 2 to supply VIO with 3.3V independent of VIN.

Resistors R4 and R5 have 0 Ω 's across them. The 0 Ω resistors can be replaced with current sense resistors for measuring LED current.

I²C Compatible Interface

The LM3509 is controlled via an I²C compatible interface. START and STOP conditions classify the beginning and the end of the I²C session. A START condition is defined as SDA transitioning from HIGH to LOW while SCL is HIGH. A STOP condition is defined as SDA transitioning from LOW to HIGH while SCL is HIGH. The I²C master always generates START and STOP conditions. The I²C bus is considered busy after a START condition and free after a STOP condition. During data transmission the I²C master can generate repeated START conditions. A START and a repeated START conditions are equivalent function-wise. The data on SDA must be stable during the HIGH period of the clock signal (SCL). In other words, the state of SDA can only be changed when SCL is LOW.

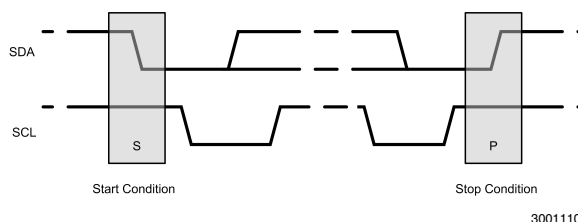

FIGURE 4. Start and Stop Sequences

I²C Compatible Address

The chip address for the LM3509 is 0110110 (36h). After the START condition, the I²C master sends the 7-bit chip address followed by a read or write bit (R/W). R/W = 0 indicates a WRITE and R/W = 1 indicates a READ. The second byte following the chip address selects the register address to which the data will be written. The third byte contains the data for the selected register.

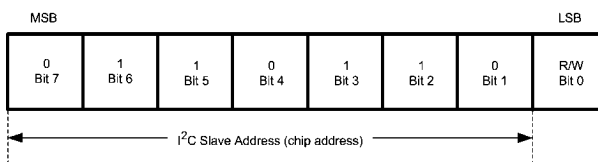

FIGURE 5. Chip Address

Transferring Data

Every byte on the SDA line must be eight bits long, with the most significant bit (MSB) transferred first. Each byte of data must be followed by an acknowledge bit (ACK). The acknowledge related clock pulse (9th clock pulse) is generated by the

master. The master releases SDA (HIGH) during the 9th clock pulse. The LM3509 pulls down SDA during the 9th clock pulse, signifying an acknowledge. An acknowledge is generated after each byte has been received. Figure 6 is an example of a write sequence to the General Purpose register of the LM3509.

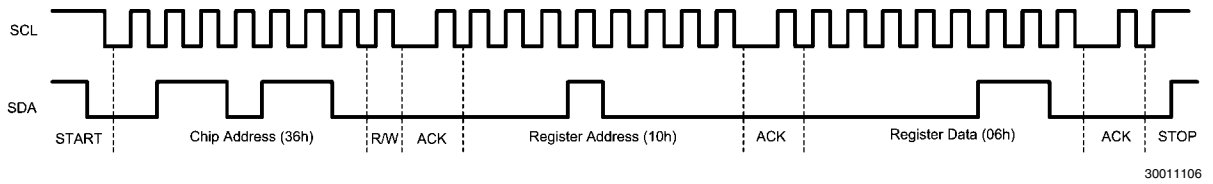

FIGURE 6. Write Sequence to the LM3509

Register Descriptions

There are 4, 8 bit registers within the LM3509 as detailed in Table 1.

Table 1. LM3509 Register Descriptions

| Register Name | Hex Address | Power -On-Value |
|----------------------------|-------------|-----------------|
| General Purpose (GP) | 10 | 0xC0 |
| Brightness Main (BMAIN) | A0 | 0xE0 |
| Brightness Sub (BSUB) | B0 | 0xE0 |
| General Purpose I/O (GPIO) | 80 | 0XF8 |

General Purpose Register (GP)

The General Purpose register has four functions. It controls the on/off state of MAIN and SUB/FB, it selects between Unison or Non-Unison mode, provides for control over the rate of

change of the LED current (see Brightness Rate of Change Description), and selects between White LED and OLED mode. Figure 7 and Table 1 describes each bit available within the General Purpose Register.

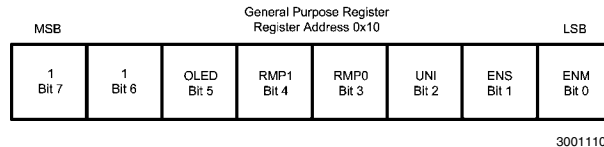

FIGURE 7. General Purpose Register Description

Table 2. General Purpose Register Bit Function

| Bit | Name | Function | Power-On-Value |
|-----|------------|--|----------------|
| 0 | ENM | Enable MAIN. Writing a 1 to this bit enables the main current sink (MAIN). Writing a 0 to this bit disables the main current sink and forces MAIN high impedance. | 0 |
| 1 | ENS | Enable SUB/FB. Writing a 1 to this bit enables the secondary current sink (SUB/FB). Writing a 0 to this bit disables the secondary current sink and forces SUB/FB high impedance. | 0 |
| 2 | UNI | Unison Mode Select. Writing a 1 to this bit disables the BSUB register and causes the contents of BMAIN to set the current in both the MAIN and SUB/FB current sinks. Writing a 0 to this bit allows the current into MAIN and SUB/FB to be independently controlled via the BMAIN and BSUB registers respectively. | 0 |
| 3 | RMP0 | Brightness Rate of Change. Bits RMP0 and RMP1 set the rate of change of the LED current into MAIN and SUB/FB in response to changes in the contents of registers BMAIN and BSUB (see brightness rate of change description). | 0 |
| 4 | RMP1 | | 0 |
| 5 | OLED | OLED = 0 places the LM3509 in White LED mode. In this mode both the MAIN and SUB/FB current sinks are active. The boost converter ensures there is at least 500mV at V_{MAIN} and $V_{SUB/FB}$. OLED = 1 places the LM3509 in OLED mode. In this mode the boost converter regulates $V_{SUB/FB}$ to 1.21V. V_{MAIN} is unregulated and must be > 300mV for the MAIN current sink to maintain current regulation. | 0 |
| 6 | Don't Care | These are non-functional read only bits. They will always read back as a 1. | 1 |
| 7 | | | |

Table 3. Operational Truth Table

| UNI | OLED | ENM | ENS | Result |
|-----|------|-----|-----|---|
| X | 0 | 0 | 0 | LM3509 Disabled |
| 1 | 0 | 1 | X | MAIN and SUB/FB current sinks enabled. Current levels set by contents of BMAIN. |
| 1 | 0 | 0 | X | MAIN and SUB/FB Disabled |
| 0 | 0 | 0 | 1 | SUB/FB current sink enabled. Current level set by BSUB. |
| 0 | 0 | 1 | 0 | MAIN current sink enabled. Current level set by BMAIN. |
| 0 | 0 | 1 | 1 | MAIN and SUB/FB current sinks enabled. Current levels set by contents of BMAIN and BSUB respectively. |
| X | 1 | 1 | X | SUB/FB current sink disabled (SUB/FB configured as a feedback pin). MAIN current sink enabled current level set by BMAIN. |
| X | 1 | 0 | X | SUB/FB current sink disabled (SUB/FB configured as a feedback pin). MAIN current sink disabled. |

* ENM ,ENS, or OLED high enables analog circuitry.

Brightness Registers (BMAIN and BSUB)

With the UNI bit (General Purpose register) set to 0 (Non-Unison mode) both brightness registers (BMAIN and BSUB) independently control the LED currents I_{MAIN} and $I_{SUB/FB}$ respectively. BMAIN and BSUB are both 8 bit, but with only the 5 LSB's controlling the current. The three MSB's are don't cares. The LED current control is designed to approximate an exponentially increasing response of the LED current vs increasing code in either BMAIN or BSUB (see Figure 10). Program I_{LED_MAX} by connecting a resistor (R_{SET}) from SET to GND, where:

$$I_{LED_MAX} = 192 \times \frac{1.244V}{R_{SET}}$$

With the UNI bit (General Purpose register) set to 1 (Unison mode), BSUB is disabled and BMAIN sets both I_{MAIN} and $I_{SUB/FB}$. This prevents the independent control of I_{MAIN} and $I_{SUB/FB}$, however matching between current sinks goes from typi-

cally 1% (with UNI = 0) to typically 0.15% (with UNI = 1). Figure 8 and Figure 9 show the register descriptions for the Brightness MAIN and Brightness SUB registers. Table 4 and Figure 10 show I_{MAIN} and/or $I_{SUB/FB}$ vs. brightness data as a percentage of I_{LED_MAX} .

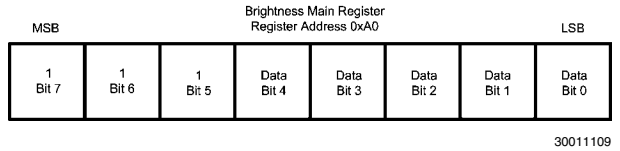

FIGURE 8. Brightness MAIN Register Description

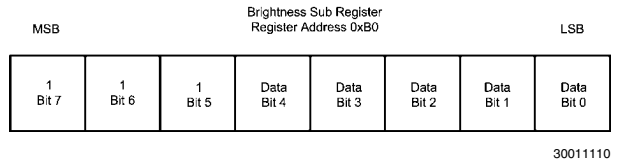
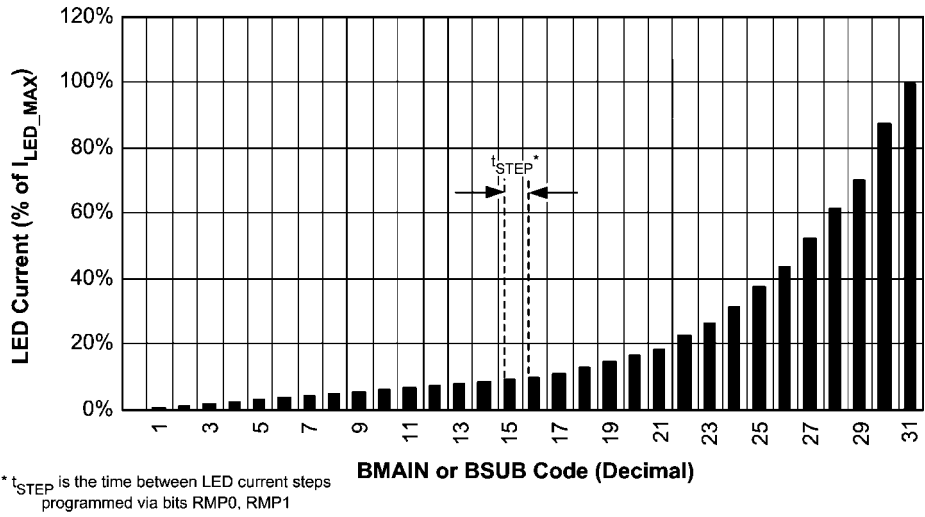

FIGURE 9. Brightness SUB Register Description

Table 4. I_{LED} vs. Brightness Register Data

| BMAIN or BSUB Brightness Data | % of ILED_MAX | BMAIN or BSUB Brightness Data | % of ILED_MAX |
|-------------------------------|---------------|-------------------------------|---------------|
| 00000 | 0.000% | 10000 | 8.750% |
| 00001 | 0.125% | 10001 | 10.000% |
| 00010 | 0.625% | 10010 | 12.500% |
| 00011 | 1.000% | 10011 | 15.000% |
| 00100 | 1.125% | 10100 | 16.875% |
| 00101 | 1.313% | 10101 | 18.750% |
| 00110 | 1.688% | 10110 | 22.500% |
| 00111 | 2.063% | 10111 | 26.250% |
| 01000 | 2.438% | 11000 | 31.250% |
| 01001 | 2.813% | 11001 | 37.500% |
| 01010 | 3.125% | 11010 | 43.750% |
| 01011 | 3.750% | 11011 | 52.500% |
| 01100 | 4.375% | 11100 | 61.250% |
| 01101 | 5.250% | 11101 | 70.000% |
| 01110 | 6.250% | 11110 | 87.500% |
| 01111 | 7.500% | 11111 | 100.000% |



30011111

FIGURE 10. I_{MAIN} or I_{SUB} vs BMAIN or BSUB Data

Brightness Rate of Change Description

RMP0 and RMP1 control the rate of change of the LED current I_{MAIN} and $I_{SUB/FB}$ in response to changes in BMAIN and / or BSUB. There are 4 user programmable LED current rates of change settings for the LM3509 (see Table 5).

Table 5. Rate of Change Bits

| RMP0 | RMP1 | Change Rate (t_{STEP}) |
|------|------|----------------------------|
| 0 | 0 | 51µs/step |
| 0 | 1 | 13ms/step |
| 1 | 0 | 26ms/step |
| 1 | 1 | 52ms/step |

The total time to transition from one brightness code to another is:

$$t_{transition} = (|InitialCode - FinalCode| - 1) \times t_{STEP}$$

Table 6. GPIO Register Function

| Bits 7 – 3 | Data (Bit 2) | Mode (Bit 1) | Enable GPIO (Bit 0) | Function |
|------------|--------------|--------------|---------------------|--|
| X | X | X | 0 | RESET/GPIO is configured as an active low reset input. This is the default power on state. |
| X | Logic Input | 0 | 1 | RESET/GPIO is configured as a logic input. The logic state applied to RESET/GPIO can be read via bit 2 of the GPIO register. |
| X | Logic Output | 1 | 1 | RESET/GPIO is configured as a logic output. A 0 in bit 2 forces RESET/GPIO low. A 1 in bit 2 forces RESET/GPIO high impedance. |

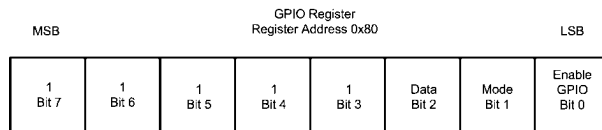

30011113

FIGURE 11. GPIO Register Description

Where t_{STEP} is given in Table 5.

General Purpose I/O (GPIO)

RESET/GPIO has three functions; an active low reset input, a logic input, and an open drain logic output. The default setting is as an active low reset input. Write a '1' to bit 0 of the GPIO register (address 0x80) to configure RESET/GPIO as a general purpose I/O (GPIO). In this mode, bit 1 of the GPIO register controls the input/output state of RESET/GPIO. With bit 1 = '0', RESET/GPIO is configured as a logic input and the data is read back via bit 2 of the GPIO register. With bit 1 = '1', RESET/GPIO is configured as a logic output. In this mode bit 2 of the GPIO register becomes the output data. Write a '1' to bit 2 to force RESET/GPIO to a logic one. Write a '0' to bit 2 to force RESET/GPIO to a logic zero. (see Table 6, and figure 11) .

LM3509 I²C Compatible Interface Program

In order to fully evaluate the LM3509 with the National Semiconductor USB Interface Board, National has created an I²C compatible program (LM3509 .exe) . To begin with, plug the LM3509 evaluation board into the USB docking board via the USBL and USBR connectors and plug the National Semiconductor USB Interface Board into a PC via a standard USB cable. The USB docking board will provide all of the control signals for the simple interface as well as power to the LM3509 Evaluation Board.

A jumper on the LM3509 evaluation board labeled VIN/USB allows the user to either connect an external power supply to the IN header on the LM3509 evaluation board, or draw power from the docking board. If the jumper is installed the USB docking board supplies power to the LM3509 Evaluation board. Removal of the jumper disconnects the 3.3V supply from the USB Interface Board. Once removed, an external supply is required at the IN header. For proper operation, the USB docking board must be plugged into the PC before the interface program is opened.

Once connected, and the program is executed, a basic interface window will open. (see Figure 12). At the top of the interface, the user can read or write to any of the data registers on the LM3509 using the two pull down menus for the slave I.D. and the desired data address.

The data field to the right of the Address pull-down menu accepts hex data while the read and write buttons directly below the Address pull-down menu execute the Read or Write command. Just below the Write and Read buttons are 5 enable

buttons. Two dedicated enable bits (ENM and ENS) will enable the two LED banks (MAIN and SUB). A dedicated bit (UNI) enables the unity function of the two LED banks, and another bit (OLED) puts the part in OLED mode. The Enable All button simultaneously enables both ENS and ENM.

Below the enable buttons are two sliding bars and data fields that allow all 32 levels of brightness for the MAIN and SUB banks. Just below the 2 brightness level slider bars are 6 convenient action buttons: 3 set buttons and 3 reset buttons.

SetM sets the MAIN brightness level to full-scale and enables the MAIN bank.

ResetM resets the MAIN brightness level to zero and disables the MAIN bank.

SetS sets the SUB brightness level to full-scale and enables the SUB bank.

ResetS resets the SUB brightness level to zero and disables the SUB bank.

Set sets the MAIN and the SUB brightness levels to full scale and enables the MAIN and SUB banks.

ResetM resets the MAIN and SUB brightness levels to zero and disables the MAIN and SUB banks.

To the right of the 2 brightness level slider bars are 2 pulldown menus which control the ramp rate of the brightness levels and the delay between turning on the LM3509's boost converter and the enabling of the current sources. To the left of the 2 brightness level slider bars are convenient controls for the Hardware **RESET** /GPIO pin. NOTE: If the part is enabled to any brightness level and the program is closed, the LM3509 will remain in the last programmed state.

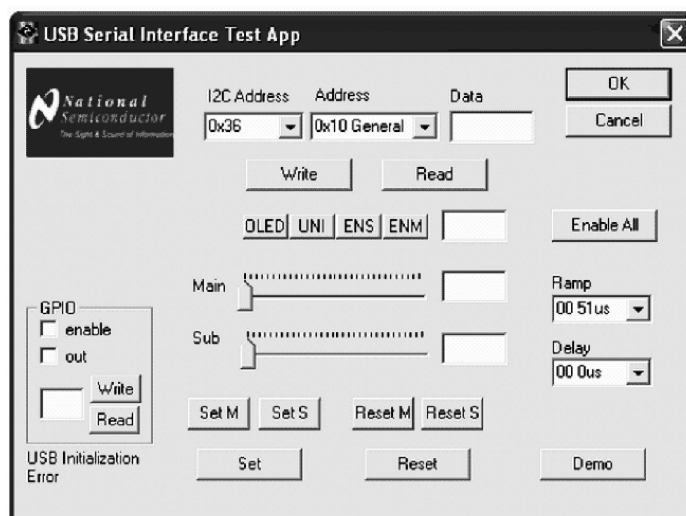

30011116

FIGURE 12. LM3509.exe

Applications Information

LED Current Setting/Maximum LED Current

Resistor R_{SET} connected from SET to GND sets the maximum LED current. The board is shipped with a $12.1k\Omega$ for R_{SET} giving a maximum LED current of 20mA/string. For higher or lower maximum LED currents the $12.1k\Omega$ can be removed and replaced with another value for R_{SET} . In this case the R_{SET} to I_{LED_MAX} relationship is:

$$I_{LED_MAX} = 192 \times \frac{1.244V}{R_{SET}}$$

where SET provides the constant 1.244V output. Typically the MAIN and SUB current sinks can provide up to 30mA.

Output Voltage Setting (OLED Mode)

For applications that require a constant output voltage + a single LED string (such as OLED panel powering) the

LM3509 features an OLED mode (OLED bit = '1'). In OLED mode connect feedback resistors from the converters output to SUB/FB to GND to set the output voltage (see R1 and R2 in Figure 1. First select $R2 < 100k\Omega$ then calculate R1 such that:

$$R1 = R2 \left(\frac{V_{OUT}}{1.21V} - 1 \right)$$

In OLED mode the MAIN current sink continues to regulate the current through MAIN, however, V_{MAIN} is no longer regulated. To avoid dropout and ensure proper current regulation the application must ensure that $V_{MAIN} > 0.3V$.

Notes

Notes

THE CONTENTS OF THIS DOCUMENT ARE PROVIDED IN CONNECTION WITH NATIONAL SEMICONDUCTOR CORPORATION ("NATIONAL") PRODUCTS. NATIONAL MAKES NO REPRESENTATIONS OR WARRANTIES WITH RESPECT TO THE ACCURACY OR COMPLETENESS OF THE CONTENTS OF THIS PUBLICATION AND RESERVES THE RIGHT TO MAKE CHANGES TO SPECIFICATIONS AND PRODUCT DESCRIPTIONS AT ANY TIME WITHOUT NOTICE. NO LICENSE, WHETHER EXPRESS, IMPLIED, ARISING BY ESTOPPEL OR OTHERWISE, TO ANY INTELLECTUAL PROPERTY RIGHTS IS GRANTED BY THIS DOCUMENT.

TESTING AND OTHER QUALITY CONTROLS ARE USED TO THE EXTENT NATIONAL DEEMS NECESSARY TO SUPPORT NATIONAL'S PRODUCT WARRANTY. EXCEPT WHERE MANDATED BY GOVERNMENT REQUIREMENTS, TESTING OF ALL PARAMETERS OF EACH PRODUCT IS NOT NECESSARILY PERFORMED. NATIONAL ASSUMES NO LIABILITY FOR APPLICATIONS ASSISTANCE OR BUYER PRODUCT DESIGN. BUYERS ARE RESPONSIBLE FOR THEIR PRODUCTS AND APPLICATIONS USING NATIONAL COMPONENTS. PRIOR TO USING OR DISTRIBUTING ANY PRODUCTS THAT INCLUDE NATIONAL COMPONENTS, BUYERS SHOULD PROVIDE ADEQUATE DESIGN, TESTING AND OPERATING SAFEGUARDS.

EXCEPT AS PROVIDED IN NATIONAL'S TERMS AND CONDITIONS OF SALE FOR SUCH PRODUCTS, NATIONAL ASSUMES NO LIABILITY WHATSOEVER, AND NATIONAL DISCLAIMS ANY EXPRESS OR IMPLIED WARRANTY RELATING TO THE SALE AND/OR USE OF NATIONAL PRODUCTS INCLUDING LIABILITY OR WARRANTIES RELATING TO FITNESS FOR A PARTICULAR PURPOSE, MERCHANTABILITY, OR INFRINGEMENT OF ANY PATENT, COPYRIGHT OR OTHER INTELLECTUAL PROPERTY RIGHT.

LIFE SUPPORT POLICY

NATIONAL'S PRODUCTS ARE NOT AUTHORIZED FOR USE AS CRITICAL COMPONENTS IN LIFE SUPPORT DEVICES OR SYSTEMS WITHOUT THE EXPRESS PRIOR WRITTEN APPROVAL OF THE CHIEF EXECUTIVE OFFICER AND GENERAL COUNSEL OF NATIONAL SEMICONDUCTOR CORPORATION. As used herein:

Life support devices or systems are devices which (a) are intended for surgical implant into the body, or (b) support or sustain life and whose failure to perform when properly used in accordance with instructions for use provided in the labeling can be reasonably expected to result in a significant injury to the user. A critical component is any component in a life support device or system whose failure to perform can be reasonably expected to cause the failure of the life support device or system or to affect its safety or effectiveness.

National Semiconductor and the National Semiconductor logo are registered trademarks of National Semiconductor Corporation. All other brand or product names may be trademarks or registered trademarks of their respective holders.

Copyright© 2007 National Semiconductor Corporation

For the most current product information visit us at www.national.com



National Semiconductor Americas Customer Support Center
 Email: new.feedback@nsc.com
 Tel: 1-800-272-9959

National Semiconductor Europe Customer Support Center
 Fax: +49 (0) 180-530-85-86
 Email: europe.support@nsc.com
 Deutsch Tel: +49 (0) 69 9508 6208
 English Tel: +49 (0) 870 24 0 2171
 Français Tel: +33 (0) 1 41 91 8790

National Semiconductor Asia Pacific Customer Support Center
 Email: ap.support@nsc.com

National Semiconductor Japan Customer Support Center
 Fax: 81-3-5639-7507
 Email: jpn.feedback@nsc.com
 Tel: 81-3-5639-7560